

- corrugated metal roofing
- bamboo rafters
- bamboo cross bracing
- bamboo ties
- wood roof joist
- wood stud wall and roof framing
- bamboo beam
- bamboo column
- FACADE SYSTEM A
- eucalyptus framed coated closed weave bamboo panel
- eucalyptus furring
- rigid insulation between studs
- closed weave bamboo panel
- wood window head
- steel casement window
- open weave bamboo shutter in eucalyptus frame
- single glazing

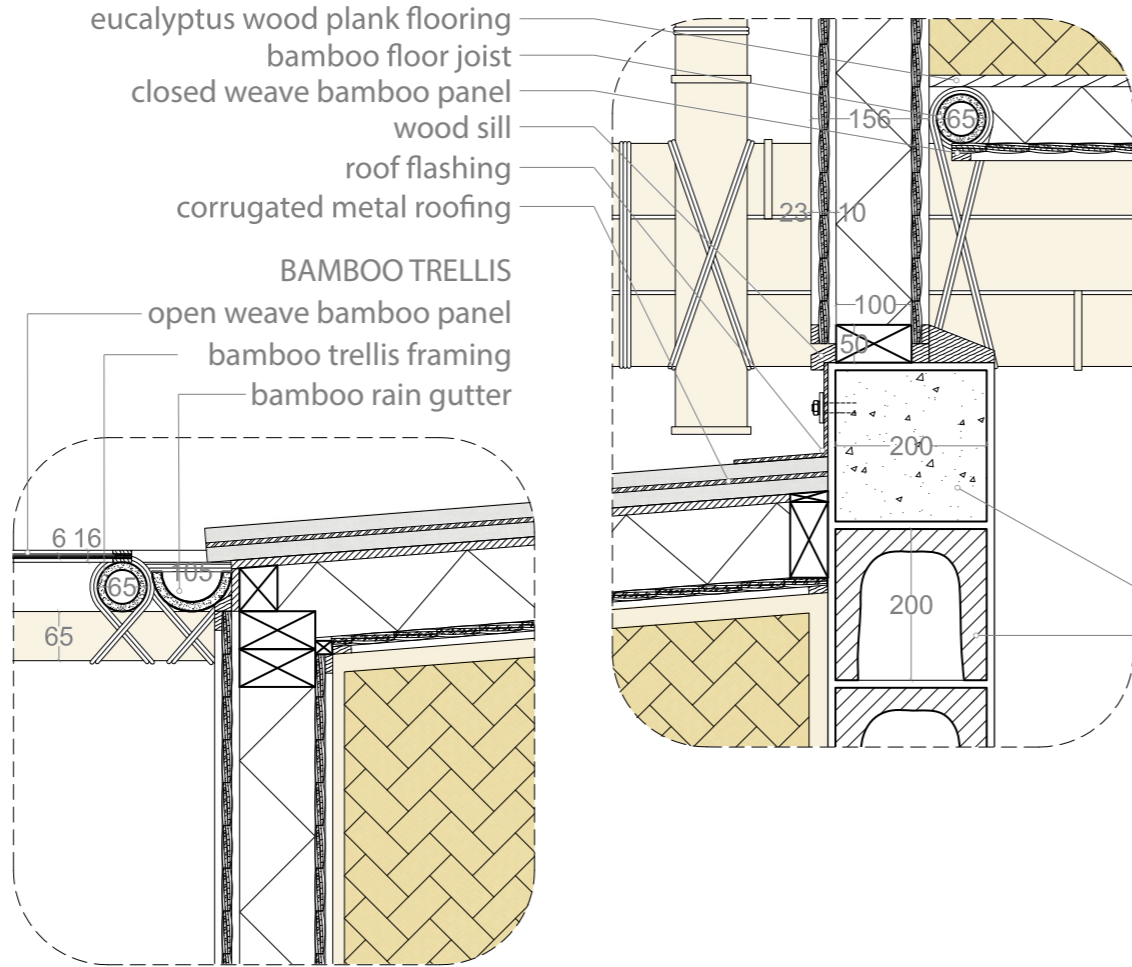

- eucalyptus wood plank flooring
- bamboo floor joist
- closed weave bamboo panel
- wood sill
- roof flashing
- corrugated metal roofing
- BAMBOO TRELLIS
- open weave bamboo panel
- bamboo trellis framing
- bamboo rain gutter

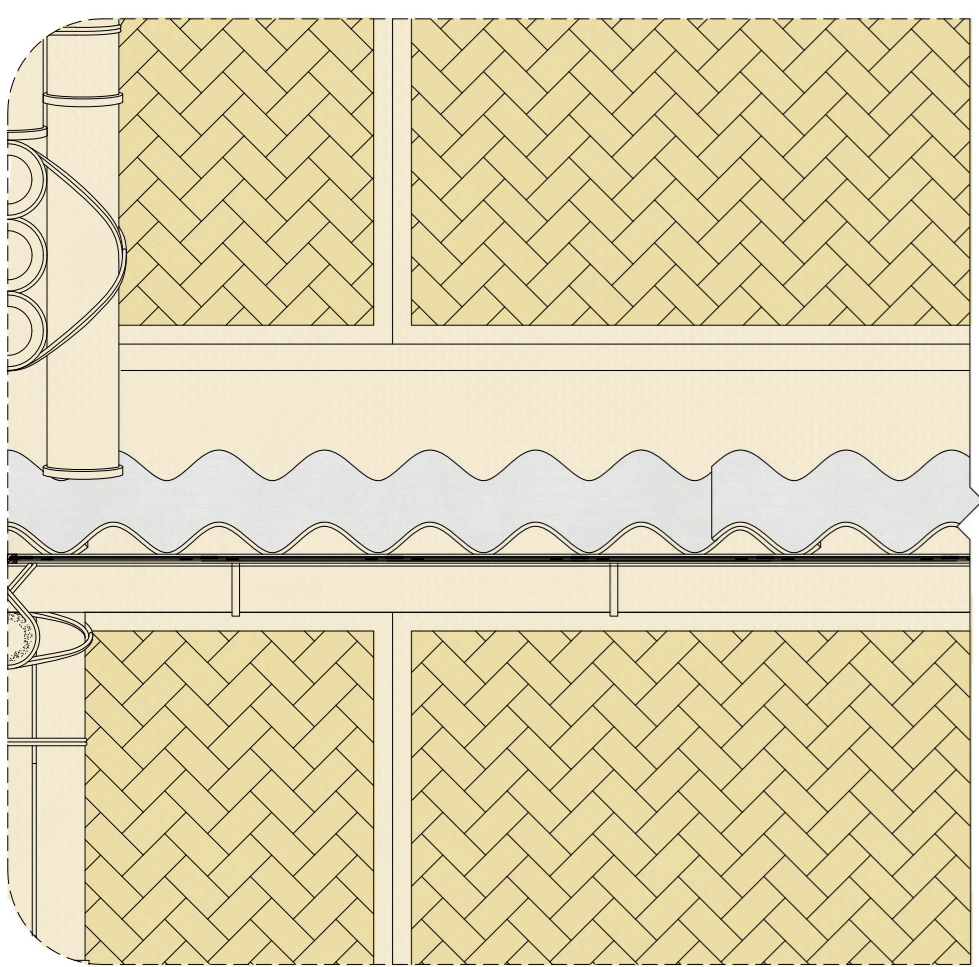
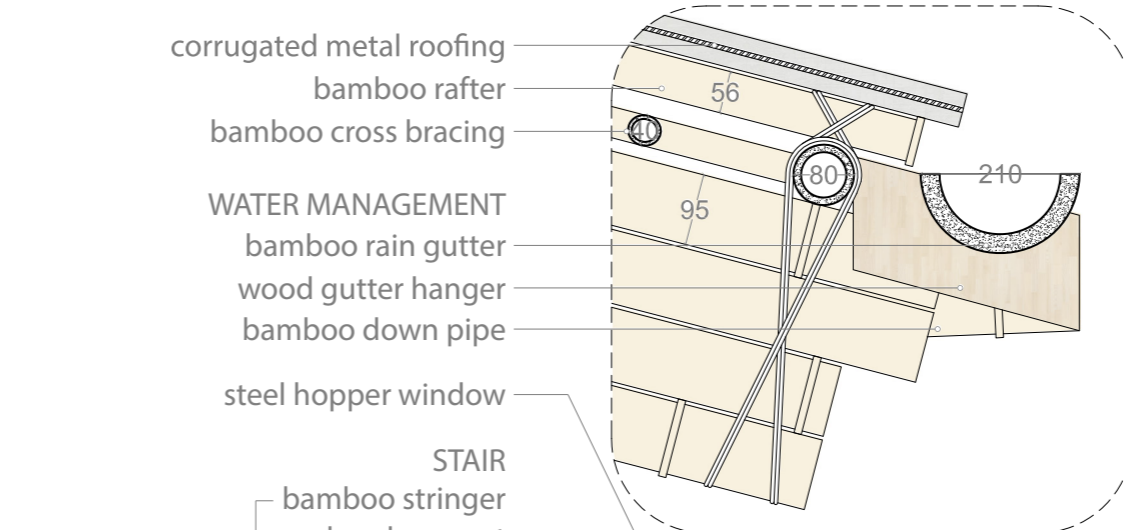

- corrugated metal roofing
- bamboo rafter
- bamboo cross bracing
- WATER MANAGEMENT
- bamboo rain gutter
- wood gutter hanger
- bamboo down pipe
- steel hopper window

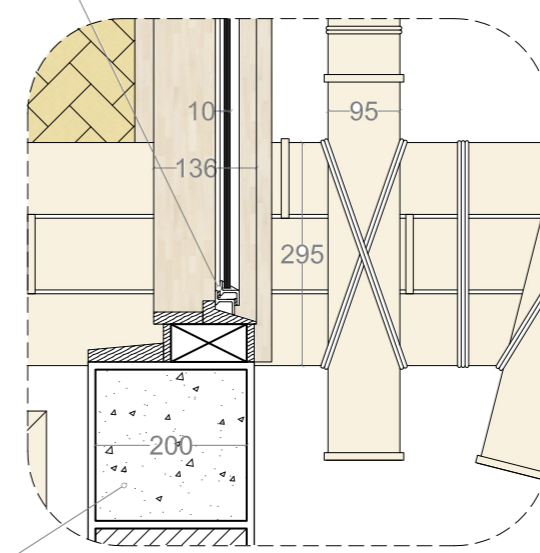
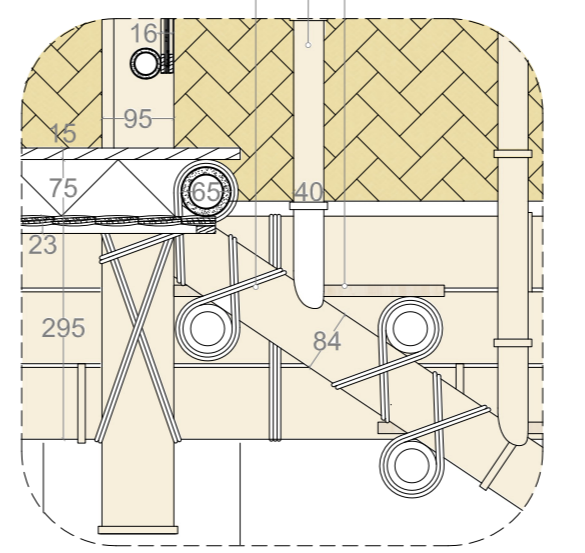
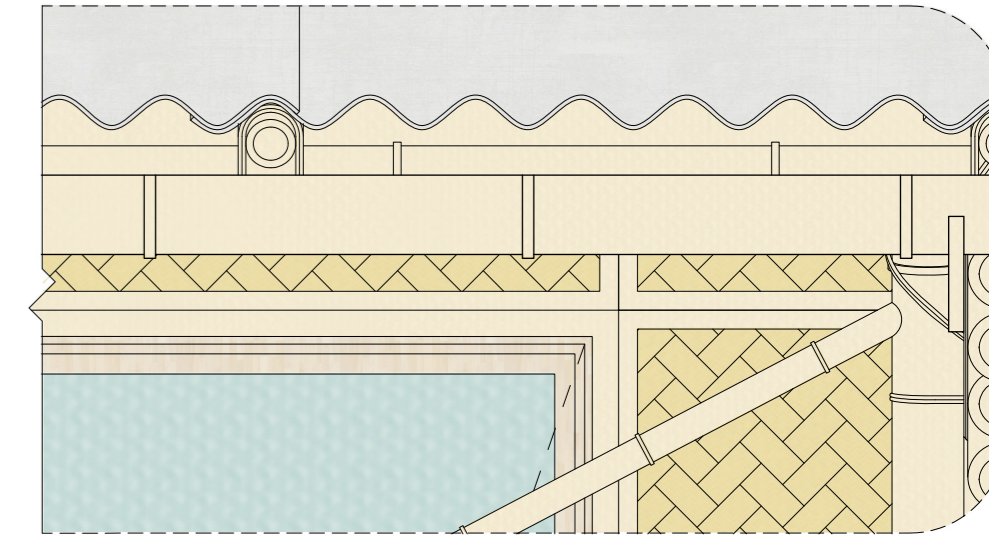

- STAIR
- bamboo stringer
- bamboo post
- wood tread

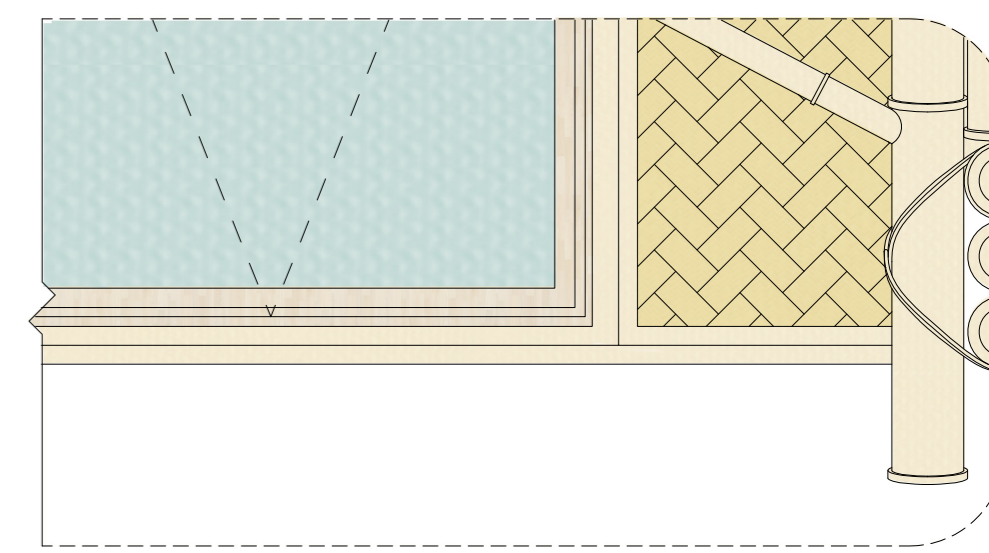

- cast-in-place concrete beam
- hollow concrete block (HCB)

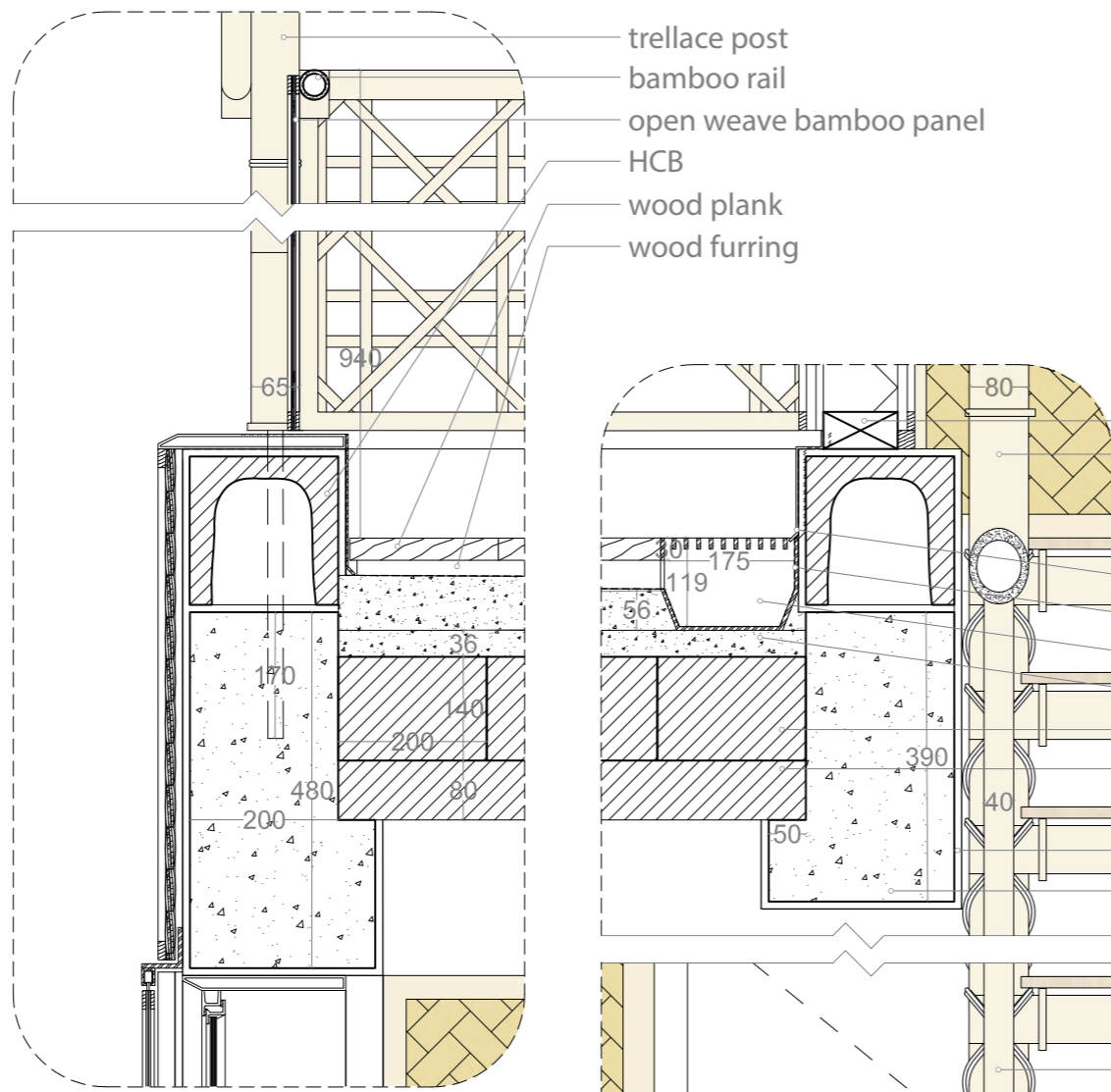
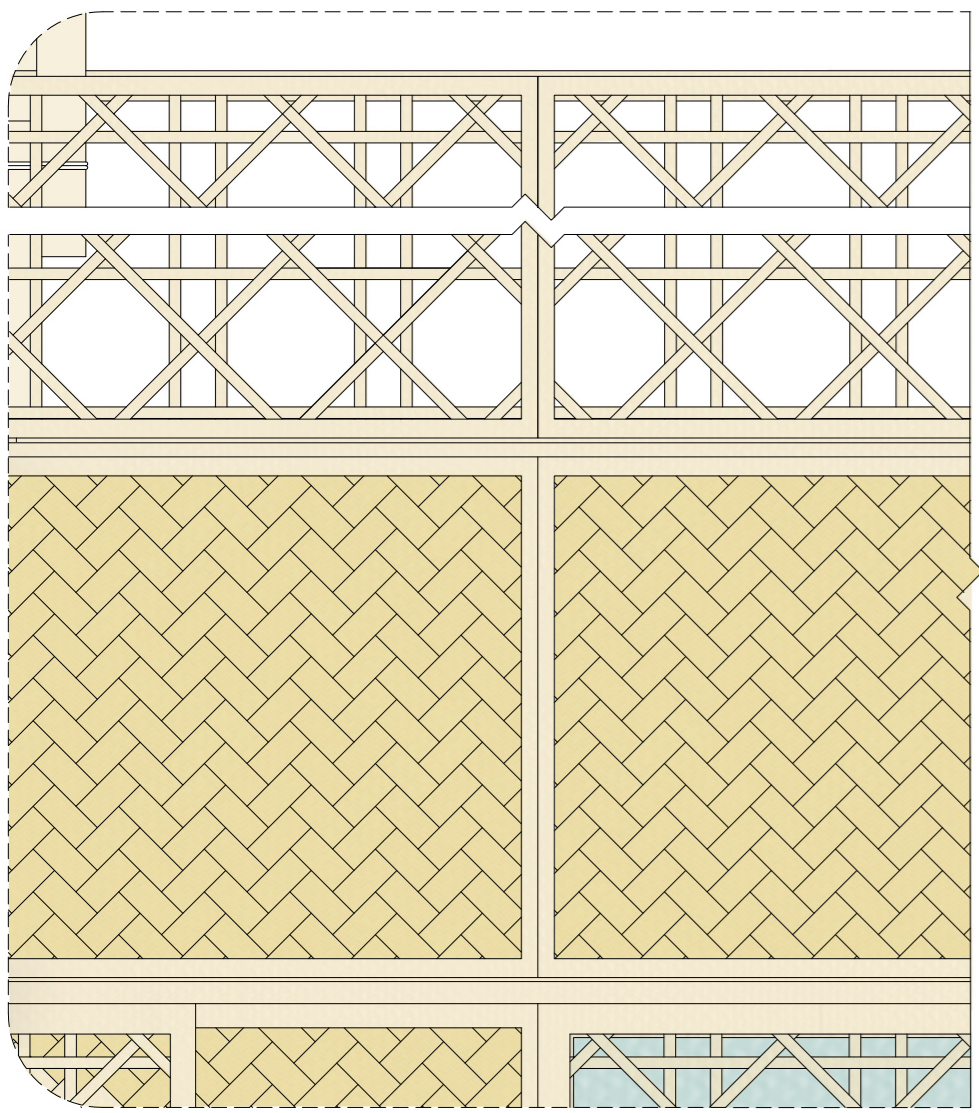

- trellis post
- bamboo rail
- open weave bamboo panel
- HCB
- wood plank
- wood furring

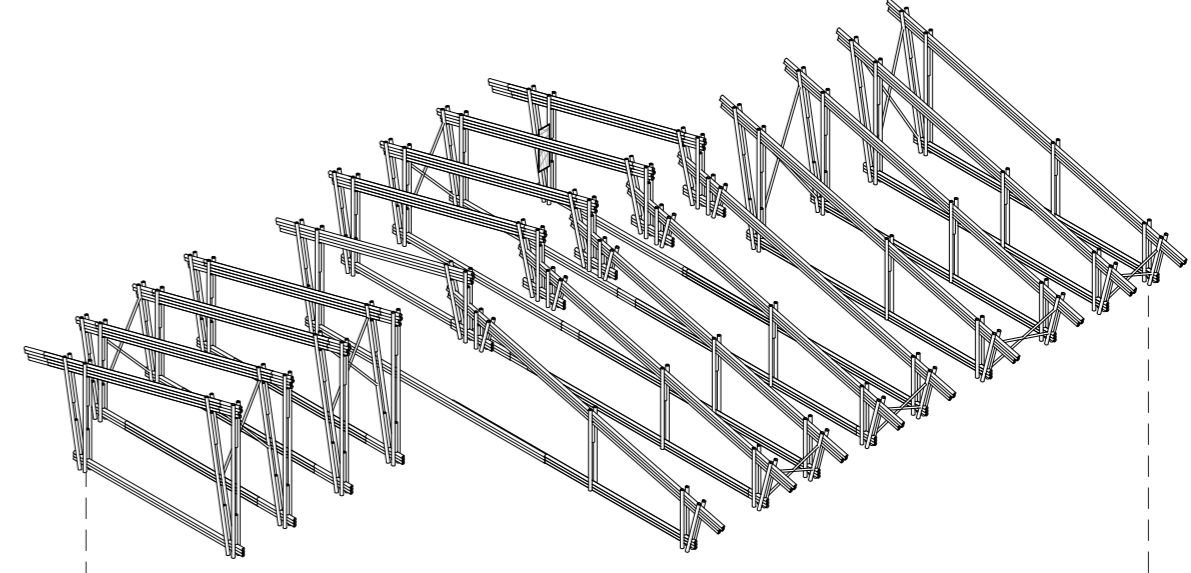

Bamboo Post and Beam Framed Penthouse and Roof

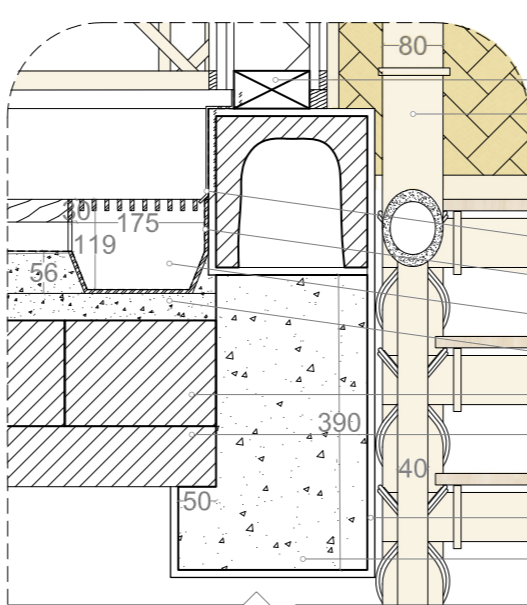

- wood stud wall
- bamboo handrail
- FLAT ROOF
- flashing
- water barrier
- drainage channel
- screed
- slab HCB
- precast concrete beam
- plaster
- cast-in-place concrete beam

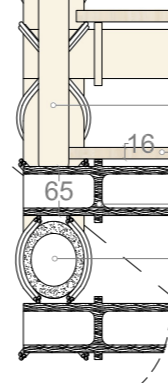

- STAIR OPTION
- bamboo post
- wood tread
- bamboo stair joist
- bamboo stringer

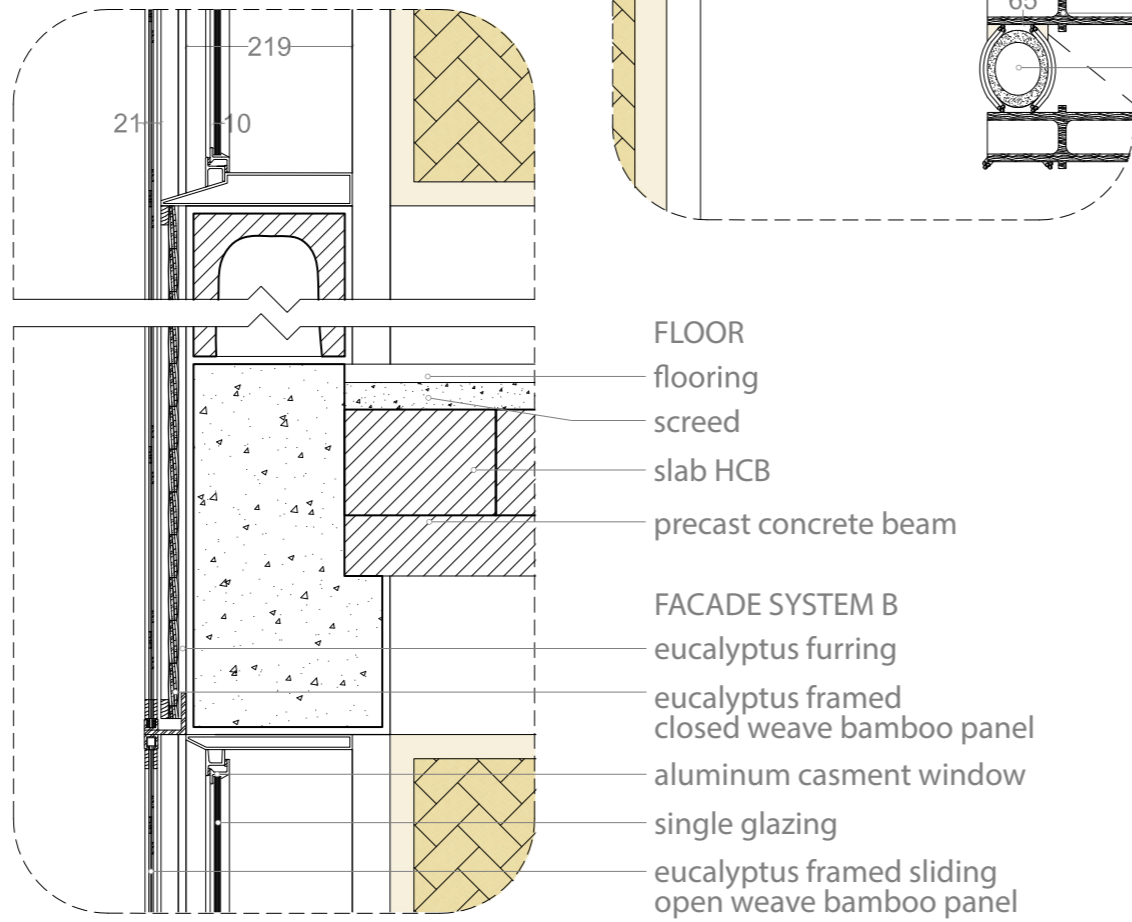
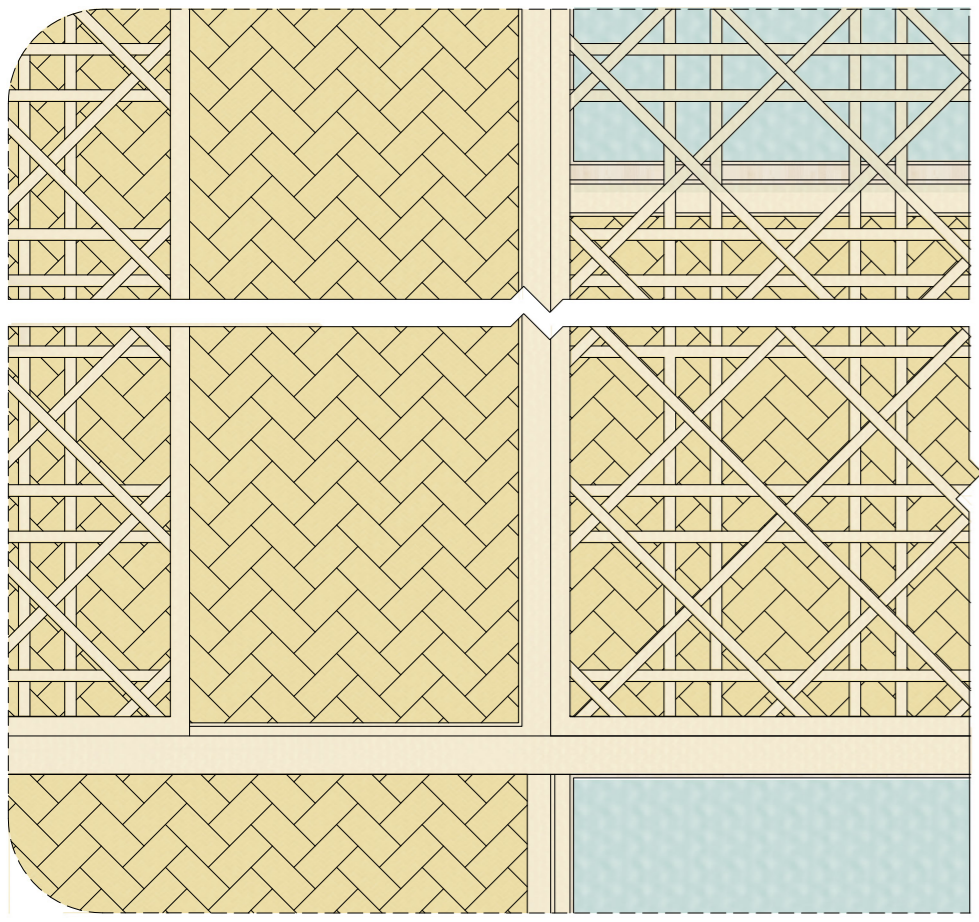

- FLOOR
- flooring
- screed
- slab HCB
- precast concrete beam
- FACADE SYSTEM B
- eucalyptus furring
- eucalyptus framed closed weave bamboo panel
- aluminum casement window
- single glazing
- eucalyptus framed sliding open weave bamboo panel

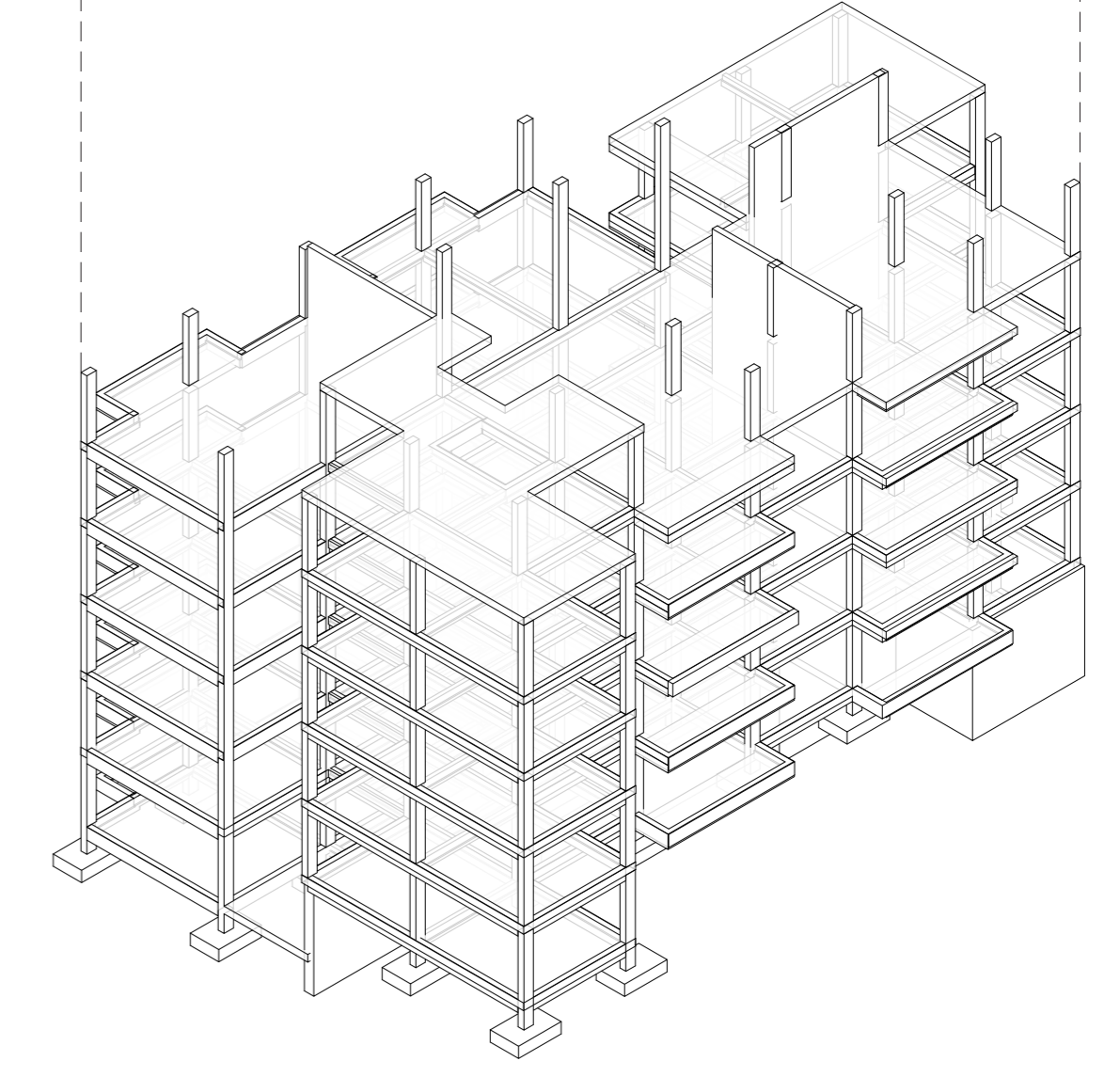

Main Load Bearing Structure

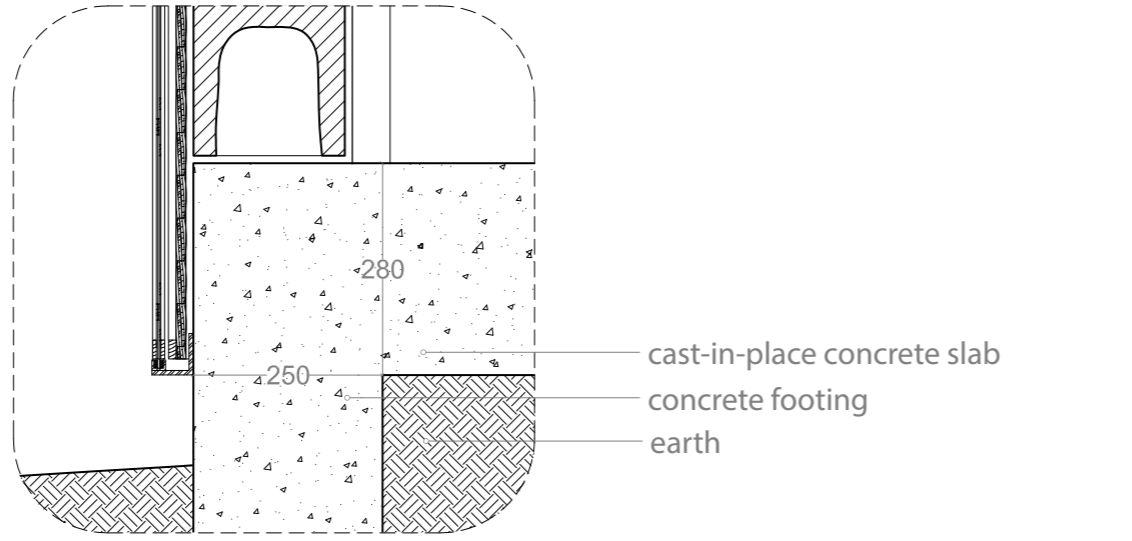

- cast-in-place concrete slab
- concrete footing
- earth

- Cast-in-Place Foundations and Slab
- Existing Cast-in-Place Concrete Columns and Beams
- Precast concrete Four Beams and Slab Hollow Concrete Blocks (HCB)
- HCB Walls

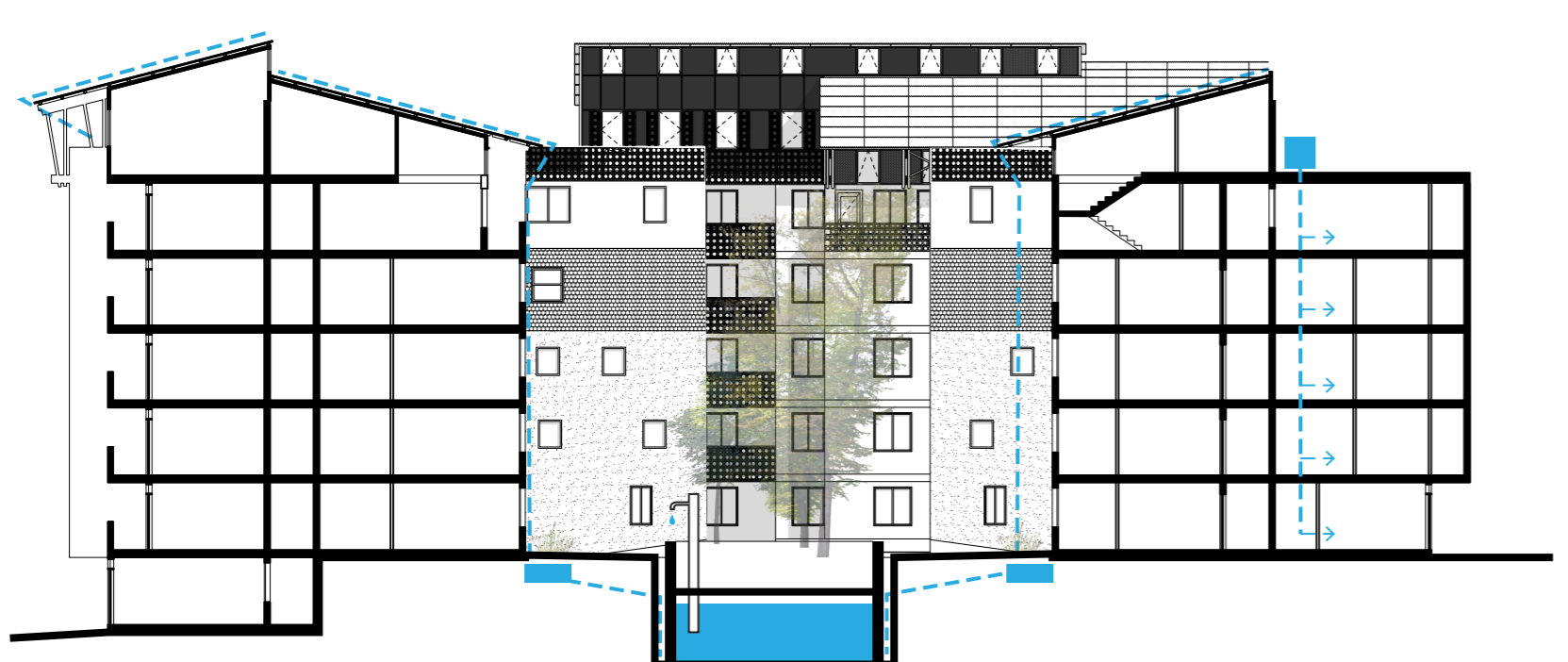

Rain Water Management

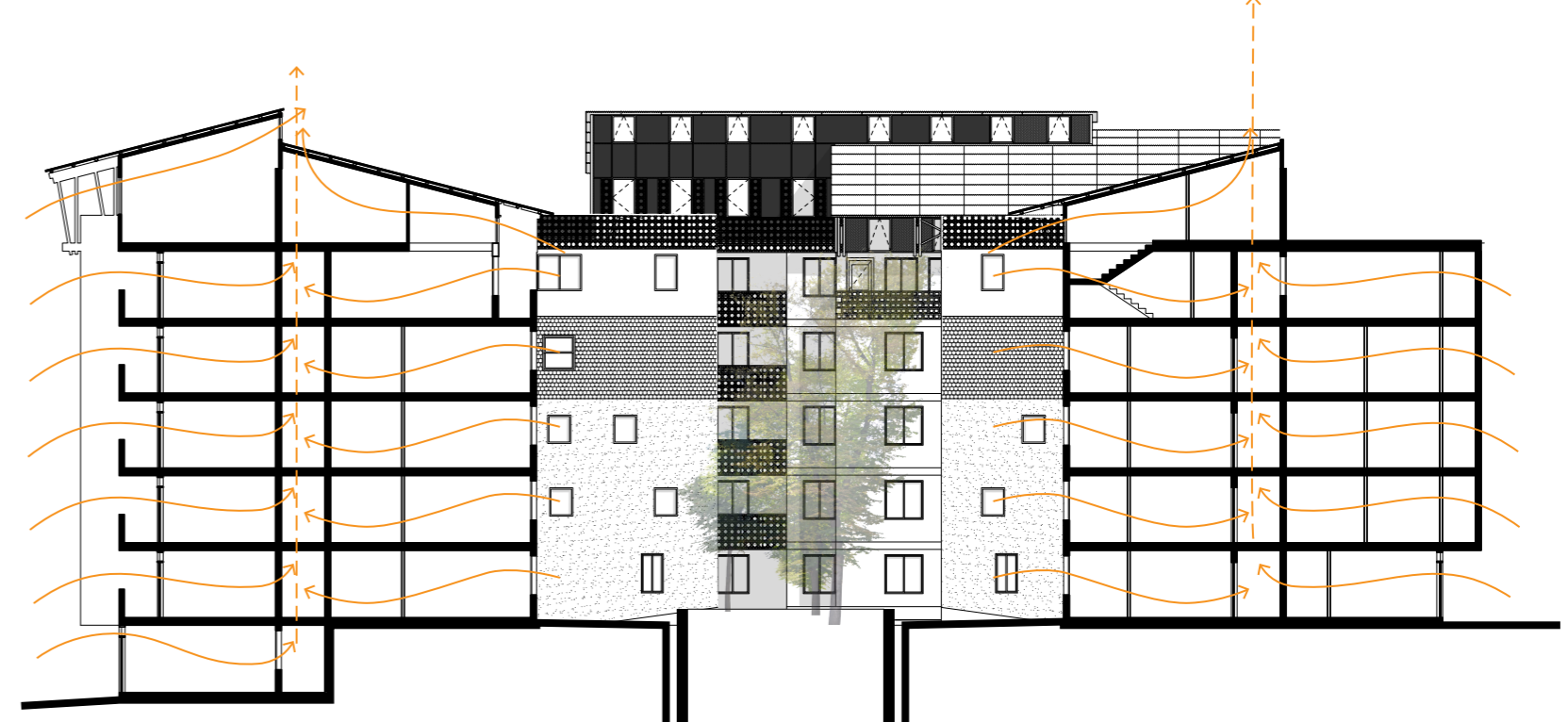

Natural Ventilation